

SERVICE-DOCUMENTATIE

KY 506

en

KY 506 N

SERVICE-DOCUMENTATIE

Ontvangstoestellen

KY 506

en

KY 506N

voor wisselstroom

Voor de service-documentaties van de toestellen KY 506 en KY 506N kan worden verwezen naar de service-documentatie van de toestellen KY 505 en KY 505N. De schakelingen komen namelijk geheel overeen met dien verstande, dat aan de toestellen KY 506 een afstemoog EM 4 toegevoegd is en aan de toestellen KY 506N een afstemoog EM 34.

De toestellen KY 506N, genummerd 7155 t/m 8155 zijn uitgerust met een luidspreker met een diameter van 21 cm. in tegenstelling met de toestellen KY 506 en de overige toestellen KY 506N, welke een luidspreker met een diameter van 17 cm. bezitten.

Alle toestellen KY 506N zijn uitgerust met de uitgangstransformator GK 512 90 (zie bij KY 505N). Alle toestellen KY 506 zijn uitgerust met de uitgangstransformator GK 512 80 (zie bij KY 505).

In alle toestellen KY 506 en KY 506N zijn de volumeregelaars stroomloos geschakeld.

Condensatoren				
C	Capaciteit	Omschrijving	Volt	Codenummer
1 2 3 4 5	13-541 $\mu\mu\text{F}$ 13-541 $\mu\mu\text{F}$ 1000 $\mu\mu\text{F}$ 5-40 $\mu\mu\text{F}$	var. cond. papiercond. 25 % bijstelcond.	500	GK 210 38 GK 202 25/1K GK 210 36
6 7 8 9 10	5-40 $\mu\mu\text{F}$ 100 $\mu\mu\text{F}$ 5-40 $\mu\mu\text{F}$ 5-40 $\mu\mu\text{F}$ 5-40 $\mu\mu\text{F}$	bijstelcond. micacond. 2 % bijstelcond. bijstelcond. bijstelcond.		GK 210 36 GK 19 02/100E GK 210 36 GK 210 36 GK 210 36
11 12 13 14 15				
16 17 18 19 20	220 $\mu\mu\text{F}$ 47 $\mu\mu\text{F}$ 470 $\mu\mu\text{F}$ 550 $\mu\mu\text{F}$ 200 $\mu\mu\text{F}$	micacond. 20 % micacond. 10 % micacond. 20 % micacond. 2 % micacond. 2 %		GK 19 20/220E GK 19 10/47E GK 19 20/470E GK 19 02/550E GK 19 02/200E
21 22 23 24 25	100 $\mu\mu\text{F}$ 100 $\mu\mu\text{F}$ 50000 $\mu\mu\text{F}$ 0,1 μF	micacond. 2 % papiercond. 20 % papiercond. 20 %	500 500	GK 190 32-1 GK 202 20/50K GK 202 20/100K
26 27 28 29 30	20000 $\mu\mu\text{F}$ 20000 $\mu\mu\text{F}$ 2500 $\mu\mu\text{F}$ 100 $\mu\mu\text{F}$ 10 $\mu\mu\text{F}$	papiercond. 20 % papiercond. 20 % papiercond. 25 % micacond. 20 % micacond. 20 %	500 500 500	GK 202 20/20K GK 202 20/20K GK 202 25/2K5 GK 19 20/100E GK 19 20/10E
31 32 33 34 35	100 $\mu\mu\text{F}$ 100 $\mu\mu\text{F}$ 0,1 μF 10000 $\mu\mu\text{F}$ 5000 $\mu\mu\text{F}$	micacond. 2 % papiercond. 20 % papiercond. 20 % papiercond. 25 %	500 500 600	GK 190 32-1 GK 202 20/100K GK 202 20/10K GK 205 25/5K

Condensatoren				
C	Capaciteit	Omschrijving	Volt	Codenummer
36	0,1 μ F	papiercond. 20 %/0	500	GK 202 20/100K
37	0,1 μ F	papiercond. 20 %/0	500	GK 202 20/100K
38	135 μ F	micacond. 5 %/0		GK 19 05/135E
39	50 μ F	electr. cond.		GK 180 11
40	50 μ F			
41	100 μ F	electr. cond.		GK 180 10
42	27 μ F	micacond. 5 %/0		GK 19 05/27E
43	47 μ F	micacond. 20 %/0		GK 19 20/47E
44	220 μ F	micacond. 20 %/0		GK 19 20/220E
45	50000 μ F	papiercond. 20 %/0	500	GK 202 20/50K
46	50000 μ F	papiercond. 20 %/0	500	GK 202 20/50K
47	10000 μ F	papiercond. 20 %/0	500	GK 202 20/10K
48	4500 μ F	micacond. 2 %/0		GK 19 02/4K5
49	20000 μ F	papiercond. 20 %/0	500	GK 202 20/10K

Weerstanden					
R	Weerstand	Omschrijving	Tol.	Watt	Codenummer
1	1 M Ω	koolweerstand	20 %	0,5	GK 776 20/1M
2	47000 Ω	koolweerstand	20 %	0,5	GK 776 20/47K
3	22000 Ω	koolweerstand	10 %	1	GK 777 10/22K
4	5600 Ω	koolweerstand	20 %	0,5	GK 776 20/5K6
5	1 M Ω	koolweerstand	20 %	0,5	GK 776 20/1M
6	1 M Ω	koolweerstand	20 %	0,5	GK 776 20/1M
7	0,27 M Ω	koolweerstand	10 %	0,5	GK 776 10/270K
8	0,82 M Ω	koolweerstand	20 %	0,5	GK 776 20/820K
9	0,1 + 0,4 M Ω	koolpot.meter			GK 808 46
10	15000 Ω	koolweerstand	20 %	0,5	GK 776 20/15K
11	1,5 M Ω	koolweerstand	20 %	0,5	GK 776 20/1M5
12	47 Ω	koolweerstand	10 %	0,5	GK 776 10/47E
13	82 Ω	koolweerstand	10 %	0,5	GK 776 10/82E
14	56000 Ω	koolweerstand	20 %	0,5	GK 776 20/56K
15	0,68 M Ω	koolweerstand	20 %	0,5	GK 776 20/680K
16	0,5 M Ω	koolpot.m. log.			GK 808 47
17	0,1 M Ω	koolweerstand	20 %	0,5	GK 776 20/100K
18	0,1 M Ω	koolweerstand	20 %	0,5	GK 776 20/100K
19	2 \times 2700 Ω	koolweerstand parallel	20 %	1	GK 777 20/2K7
20	0,39 M Ω	koolweerstand	20 %	0,5	GK 777 20/2K7 GK 776 20/390K
21	0,82 M Ω	koolweerstand	20 %	0,5	GK 776 20/820K
22	2 \times 33000 Ω	koolweerstand parallel	20 %	1	GK 777 20/33K
23	0,56 M Ω	koolweerstand	20 %	0,5	GK 777 20/33K GK 776 20/560K
24	1 M Ω	koolweerstand	20 %	0,5	GK 776 20/1M
25	1 M Ω	koolweerstand	20 %	0,5	GK 776 20/1M
26	1,8 M Ω	koolweerstand	20 %	0,5	GK 776 20/1M8
27	1,8 M Ω	koolweerstand	20 %	0,5	GK 776 20/1M8
28	3300 Ω	koolweerstand	20 %	0,5	GK 776 20/3K3
29			20 %	0,5	
30			20 %	0,5	
31	0,27 M Ω	koolweerstand	20 %	0,5	GK 776 10/270K

LIJST VAN ONDERDELEN

<i>Spoulen</i>			
S	Omschrijving	Weerstand Ω	Codenummer
S 1	Antennespoel KG	1	GK 564 16
S 5		2	
S 3	Antennespoel MG	3	GK 564 17
S 7		95	
S 4	Antennespoel LG	29	GK 564 18
S 8		155	
S 11	Oscillatorspoel KG	1	GK 564 22
S 15		13	
S 13	Oscillatorspoel MG	5	GK 564 28
S 17		2	
S 14	Oscillatorspoel LG	12	GK 564 29
S 18		3	
S 31	M.F. I spoel	8	GK 564 66
S 32		8	
S 41	M.F. II spoel	8	GK 564 67
S 42		8	
S 51	Uitgangstrafo	825	GK 51290- KY 505 N KY 506 N
S 52			
S 53			
S 54		0,55	
S 61	Voedingstrafo 110 V 125 V 150 V 200 V 220 V 250 V	12,7	GK 512 74
		14,6	
		17,1	
		35,5	
		42,2	
		50,5	
S 62		158	
S 63		176	
S 64		1	
S 65		1	
S 71	M.F. ant. filterspoel Luidspreker	31	GK 564 32 L.S. 170706 imp. 7 ohm bij 400 Hz.
S 51	Uitgangstrafo		GK 51280 KY 505- KY 506
S 52			
S 53			
S 54			

Condensatoren				
C	Capaciteit	Omschrijving	Volt	Codenummer
1				
2	13-541 μF	var. cond. papiercond. 25 % bijstelcond.	500	GK 210 38 GK 202 25/1K GK 210 36
3	13-541 μF			
4	1000 μF			
5	5-40 μF			
6	5-40 μF			
7	100 μF	micacond. 2 %		GK 19 02/100E
8	5-40 μF	bijstelcond.		GK 210 36
9	5-40 μF	bijstelcond.		GK 210 36
10	5-40 μF	bijstelcond.		GK 210 36
11				
12				
13				
14				
15				
16	220 μF	micacond. 20 %		GK 19 20/220E
17	47 μF	micacond. 10 %		GK 19 10/47E
18	470 μF	micacond. 20 %		GK 19 20/470E
19	550 μF	micacond. 2 %		GK 19 02/550E
20	200 μF	micacond. 2 %		GK 19 02/200E
21	102 μF	ker. cond. 5 %	500	49 057 51
22	102 μF	ker. cond. 5 %		49 057 51
23	50000 μF	papiercond. 20 %		GK 202 20/50K
24	0,1 μF	papiercond. 20 %		GK 202 20/100K
25				
26	20000 μF	papiercond. 20 %	500	GK 202 20/20K
27	20000 μF	papiercond. 20 %	500	GK 202 20/20K
28	2500 μF	papiercond. 25 %	500	GK 202 25/2K5
29	100 μF	micacond. 20 %		GK 19 20/100E
30	10 μF	micacond. 20 %		GK 19 20/10E
31	102 μF	ker. cond. 5 %	500	49 057 51
32	102 μF	ker. cond. 5 %		49 057 51
33	0,1 μF	papiercond. 20 %		GK 202 20/100K
34	10000 μF	papiercond. 20 %		GK 202 20/10K
35	5000 μF	papiercond. 25 %		600

<i>Condensatoren</i>				
C	Capaciteit	Omschrijving	Volt	Codenummer
36	0,1 μ F	papiercond. 20 %/o	500	GK 202 20/100K
37	0,1 μ F	papiercond. 20 %/o	500	GK 202 20/100K
38	135 μ F	micacond. 5 %/o		GK 19 05/135E
39	50 μ F	electr. cond.		GK 180 12
40	50 μ F			
41	100 μ F	electr. cond.		GK 180 10
42	27 μ F	micacond. 5 %/o		GK 19 05/27E
43	47 μ F	micacond. 20 %/o		GK 19 20/47E
44	220 μ F	micacond. 20 %/o		GK 19 20/220E
45				
46	50000 μ F	papiercond. 20 %/o	500	GK 202 20/50K
47	10000 μ F	papiercond. 20 %/o	500	GK 202 20/10K
48	4500 μ F	micacond. 2 %/o		GK 19 02/4K5
49	10000 μ F	papiercond. 20 %/o	500	GK 202 20/10K

Weerstanden					
R	Weerstand	Omschrijving	Tol.	Watt	Codenummer
1	1 M Ω	koolweerstand	20 0/0	0,5	GK 776 20/1M
2	47000 Ω	koolweerstand	20 0/0	0,5	GK 776 20/47K
3	33000 Ω	koolweerstand	10 0/0	1	GK 777 10/33K
4	5600 Ω	koolweerstand	20 0/0	0,5	GK 776 20/5K6
5	1 M Ω	koolweerstand	20 0/0	0,5	GK 776 20/1M
6	1 M Ω	koolweerstand	20 0/0	0,5	GK 776 20/1M
7	0,27 M Ω	koolweerstand	10 0/0	0,5	GK 776 10/270K
8	0,82 M Ω	koolweerstand	20 0/0	0,5	GK 776 20/820K
9	0,1 + 0,4 M Ω	koolpot.meter			GK 808 46
10	15000 Ω	koolweerstand	20 0/0	0,5	GK 776 20/15K
11	1,5 M Ω	koolweerstand	20 0/0	0,5	GK 776 20/1M5
12	39 Ω	koolweerstand	10 0/0	0,5	GK 776 10/39E
13	82 Ω	koolweerstand	10 0/0	0,5	GK 776 10/82E
14	0,1 M Ω	koolweerstand	20 0/0	0,5	GK 776 20/100K
15					
16	0,5 M Ω	koolpot.m.log.			GK 808 47
17	0,1 M Ω	koolweerstand	20 0/0	0,5	GK 776 20/100K
18	0,1 M Ω	koolweerstand	20 0/0	0,5	GK 776 20/100K
19	2 \times 2700 Ω parallel	koolweerstand	20 0/0	1	GK 777 20/2K7
20	1 M Ω	koolweerstand	20 0/0	0,5	GK 776 20/1M
21	1 M Ω	koolweerstand	20 0/0	0,5	GK 776 20/1M
22	2 \times 47000 Ω parallel	koolweerstand	20 0/0	1	GK 777 20/47K
		koolweerstand	20 0/0	1	GK 777 20/47K
23					
24	1 M Ω	koolweerstand	20 0/0	0,5	GK 776 20/1M
25	1 M Ω	koolweerstand	20 0/0	0,5	GK 776 20/1M
26					
27					
28	3300 Ω	koolweerstand	20 0/0	0,5	GK 776 20/3K3
29					
30					
31	0,27 M Ω	koolweerstand	10 0/0	0,5	GK 776 10/270K
32	27000 Ω	koolweerstand	20 0/0	1	GK 777 20/27K
33	6,8 Ω	koolweerstand	20 0/0	0,5	GK 776 20/6M8
34	1000 Ω	koolweerstand	20 0/0	0,5	GK 776 20/1K

Auteursrecht volgens de wet voorbehouden

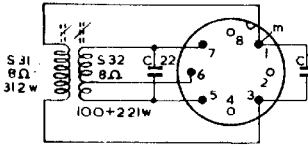

MF I SPOEL GK 564 66

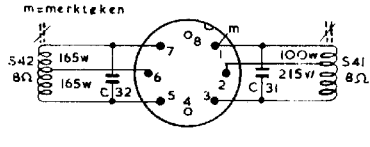

MF II SPOEL GK 564 67

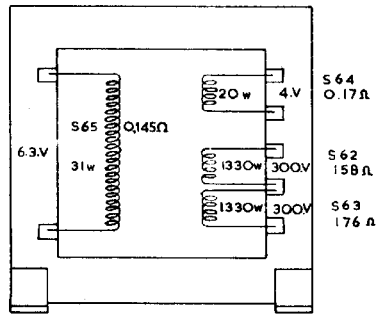
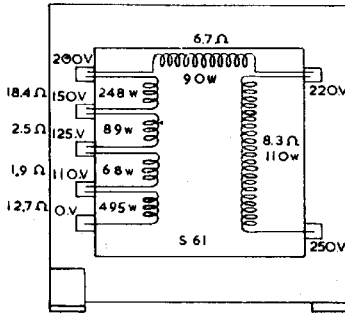

VOEDINGSTRAFO GK 512 74

gezien aan achterzijde chassis.

gezien aan voor. zijde chassis

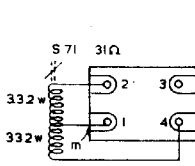

MF ANT. FILTER SP.
GK 564 32

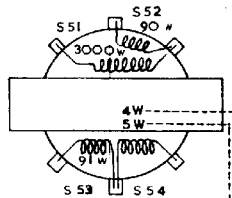

UITGANGSTRAFO
GK 512 90 KY 505N 506N
GK 512 80 KY 505 506

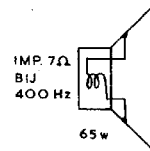

SPREK SPOEL VAN
LUIDSPR. LS 170 706

S	S*	Omschrijving	w	R Ω	codenumm.
S1	S5	ANTENNE SPOEL KG.	10,5 25,5	1 2	GK 564 16
S3	S7	ANTENNESPOEL MG	115,5 600,5	4 9,5	GK 564 17
S4	S8	ANTENNESPOEL LG.	425,5 1000,5	29 15,5	GK 564 18
S11	S15	OSCILLATOR SPOEL KG	10,5 5,5	1 13	GK 564 22
S13	S17	OSCILLATORSPOEL MG	78,5 22,5	5 2	GK 564 28
S14	S18	OSCILLATORSPOEL LG	17,75 32,5	12 3	GK 564 29

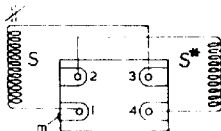
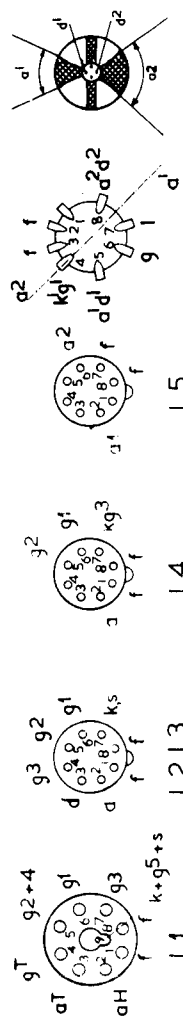
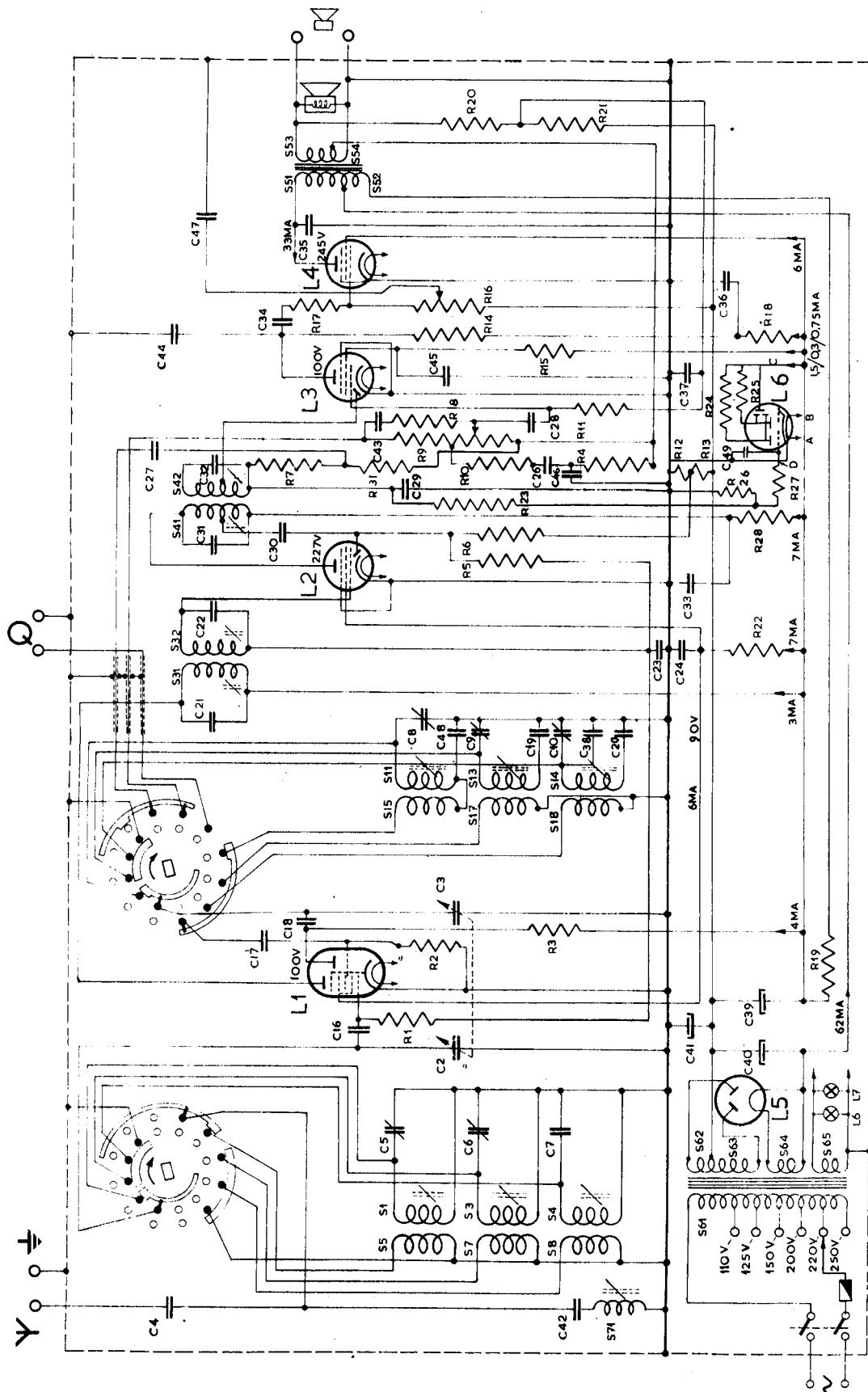

FIG 2

KY 505-505 N
506-506 N



GOLFENGTESCHAKELAAR 4 STANDEEN — KG, MG, LG, GRAM
 GETEKEND IN STAND „KG“
 SPANNINGEN GEMETEN MET VOLTMEETER 10 000 Ω/V.
 SPANNINGEN EN STROMEN ZONDER ANTENNESIGNAAL

FIG. 1

ECH21 EAF 42 EL 41 AZ 41 EM 4

KY 506

S	71, 5, 78, 134, 61 62, 63, 64, 65	31, 32,	41, 42,	51, 52, 53, 54
C	4, 42	5, 6, 7, 2, 16, 40, 41, 39, 17, 18, 3	8, 48, 9, 19, 11, 12, 14, 21, 22, 23, 24, 33, 31, 30, 29, 32, 46, 26, 27, 49, 43, 28, 37, 45, 44, 34, 35, 35, 47	
R		1, 19, 2, 3	22,	15, 14, 18, 17, 16, 20, 21

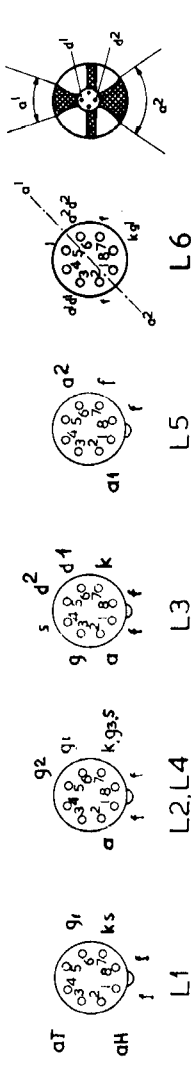
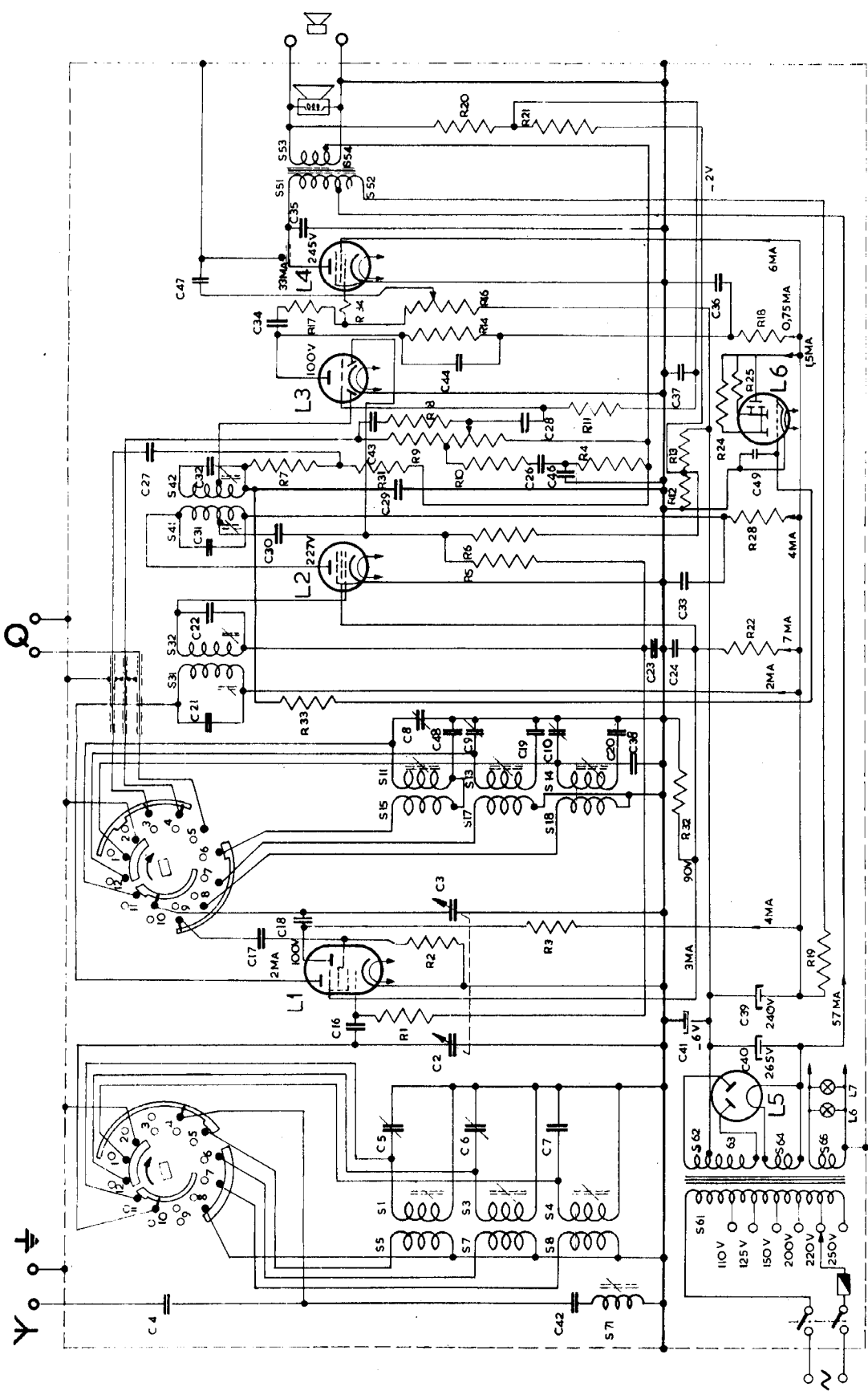

GOLFLENGTE SCHAKELAAR 4 STANDBEN — KG., MG., LG., GRAM.,
 GETEKEND IN STAND KG
 SPANNINGEN GEMETEN MET VOLTMEETER 10 000 Ω/V
 SPANNINGEN EN STROMEN ZONDER ANTENNE SIGNAAL

FIG. 1

KY 506N

ECH42 L1
 EF41 EL41 L2, L4
 EBC41 L3
 AZ41 L5
 EM34 L6

S	71, 61, 62, 63, 64, 65, 57 R, 13, 4,	41, 42	51, 52, 53, 54,
C	4, 42	14, 15, 17, 11, 18, 13	8, 48, 9, 19, 10, 20, 38, 21, 22, 23, 24, 33, 31, 30, 29, 32, 46, 26, 27, 49, 28, 37, 43, 44, 34, 47, 36, 35,
R	5, 6, 7,	2, 16, 40, 41, 36, 17, 18, 3,	5, 6, 28, 12, 7, 7, 31, 10, 4, 9, 11, 24, 25, 14, 34, 16, 17, 18,
		33	20, 21,

KY 506 —507 —508
KY 506N —507N —508N

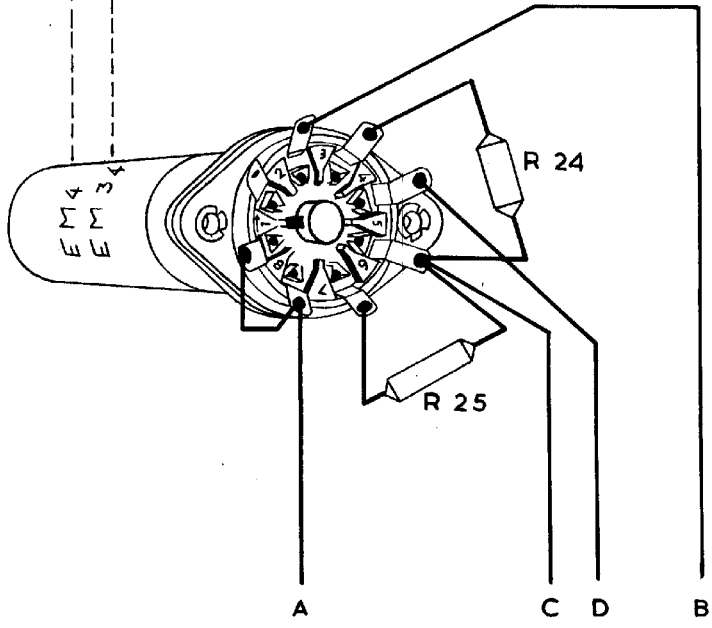

KY 506 —507 —508
KY 506N —507N —508N